

ALIGN™

COMPOSITE CLADDING

CLADDING, TRIM AND ACCESSORY CATALOG

2024



 GENTEK®

ALIGN COMPOSITE CLADDING HAS ARRIVED – AND THERE’S NOTHING ELSE LIKE IT



Superior aesthetics with installation ease and one of the best overall market values: everything perfectly ALIGNS in this innovative composite cladding from Gentek.

COLOR DEFINES THE DESIGN



From deep saturated neutrals to bold shades and light-changing grays, ALIGN’s on-trend color palette makes it easy to achieve signature style.

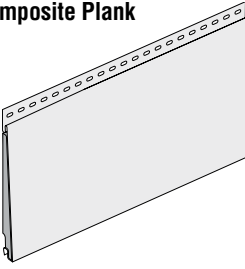
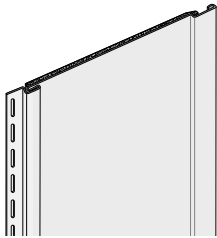
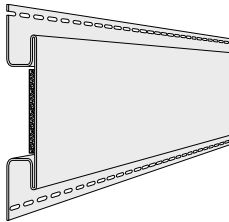
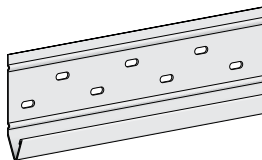
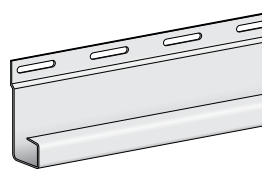

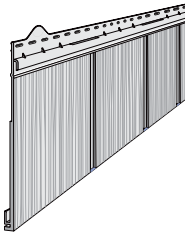
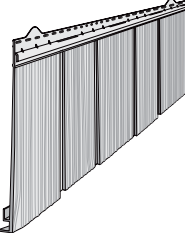
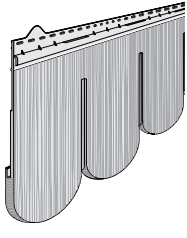
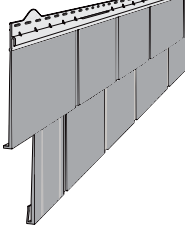
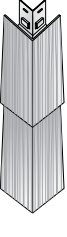

			
Snow White	Almond	Monterey Sand	Pebble
			
Dark Drift	Rockport Brown	Smoked Timber	Dover Gray
			
Chesapeake Gray	Storm	Hudson Slate	Windswept Smoke
			
Iron Ore	Coastal Blue	Harbor Bay	Midnight Surf
			
Marine Dusk	Meadow Fern	Moonlit Moss	Majestic Brick

PRODUCT	CODE	DESCRIPTION	COLORS		PACKAGING
7" ALIGN Composite Plank 	CP700	7" exposure 12'3" length 3/4" projection Cedar mill texture Low-gloss finish Reinforced nail hem	Almond 004 Chesapeake Gray 872 Coastal Blue 625 Dark Drift 665 Dover Gray 150 Harbor Bay 637 Hudson Slate 873 Iron Ore 642 Majestic Brick 876 Marine Dusk 877	Meadow Fern 874 Midnight Surf 652 Monterey Sand 673 Moonlit Moss 653 Pebble 307 Rockport Brown 875 Smoked Timber 878 Snow White 751 Storm 631 Windswept Smoke 651	1 sq/carton 14 planks/carton
	12" ALIGN Composite Board & Batten 	CP701 (Cedar mill) CP702 (Matte)	12" exposure 12' length 3/4" projection Cedar mill texture Matte texture Low-gloss finish Reinforced nail hem	Almond 004 Chesapeake Gray 872 Coastal Blue 625 Dark Drift 665 Dover Gray 150 Harbor Bay 637 Hudson Slate 873 Iron Ore 642 Majestic Brick 876 Marine Dusk 877	Meadow Fern 874 Midnight Surf 652 Monterey Sand 673 Moonlit Moss 653 Pebble 307 Rockport Brown 875 Smoked Timber 878 Snow White 751 Storm 631 Windswept Smoke 651
5-1/2" ALIGN Composite H-Trim 	CP003	5-1/2" exposure 16' length 3/4" channel pocket Matte texture Low-gloss finish	Almond 004 Chesapeake Gray 872 Coastal Blue 625 Dark Drift 665 Dover Gray 150 Harbor Bay 637 Hudson Slate 873 Iron Ore 642 Majestic Brick 876 Marine Dusk 877	Meadow Fern 874 Midnight Surf 652 Monterey Sand 673 Moonlit Moss 653 Pebble 307 Rockport Brown 875 Smoked Timber 878 Snow White 751 Storm 631 Windswept Smoke 651	10 pcs/carton
2-1/2" ALIGN Steel Starter Strip 	CP001	G90 Galvanized Steel 10' length	Universal		24 pcs/carton
ALIGN Finish Trim 	CP011	12'6" length	Snow White	751	20 pcs/carton
Nail Slot Punch 	5244R	Elongates nail slot			1 pc/carton

COLOR-MATCHED SHAKES/SCALLOPS

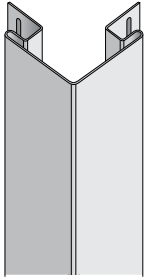
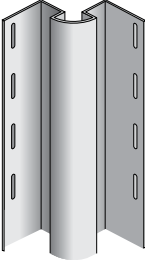
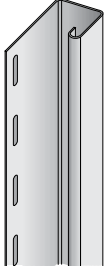
PRODUCT	CODE	DESCRIPTION	COLORS				PACKAGING				
Traditional Shake 	13988*	Single 7" exposure Polypropylene panel 81.29" length 5/8" nom. butt height Deep cedargrain texture	Almond	004	Meadow Fern	874	13 pcs/carton (1/2 sq/carton)				
			Chesapeake Gray	872	Midnight Surf	652					
			Coastal Blue	625	Monterey Sand	673					
			Dark Drift	665	Moonlit Moss	653					
			Dover Gray	150	Pebble	307					
			Harbor Bay	637	Rockport Brown	875					
			Hudson Slate	873	Smoked Timber	878					
			Iron Ore	642	Snow White	751					
			Majestic Brick	876	Storm	631					
			Marine Dusk	877	Windswept Smoke	651					
			<hr/>								
			Hand-Split Shake 	13993*	Single 9" exposure Polypropylene panel 75-1/2" length 5/8" nom. butt height Deep cedargrain texture Staggered edge bottom	Almond		004	Meadow Fern	874	11 pcs/carton (1/2 sq/carton)
						Chesapeake Gray		872	Midnight Surf	652	
Coastal Blue	625	Monterey Sand				673					
Dark Drift	665	Moonlit Moss				653					
Dover Gray	150	Pebble				307					
Harbor Bay	637	Rockport Brown				875					
Hudson Slate	873	Smoked Timber				878					
Iron Ore	642	Snow White				751					
Majestic Brick	876	Storm				631					
Marine Dusk	877	Windswept Smoke				651					
<hr/>											
Scallops 	13992*	Single 6-1/4" exposure Polypropylene panel 76.86" length 1/2" nom. butt height Natural cedargrain texture				Almond	004	Meadow Fern	874	15 pcs/carton (1/2 sq/carton)	
						Chesapeake Gray	872	Midnight Surf	652		
			Coastal Blue	625	Monterey Sand	673					
			Dark Drift	665	Moonlit Moss	653					
			Dover Gray	150	Pebble	307					
			Harbor Bay	637	Rockport Brown	875					
			Hudson Slate	873	Smoked Timber	878					
			Iron Ore	642	Snow White	751					
			Majestic Brick	876	Storm	631					
			Marine Dusk	877	Windswept Smoke	651					
			<hr/>								
			Cape Cod Shingle 	13994*	Double 5" exposure Polypropylene panel 67.33" length 1/2" nom. butt height Natural cedargrain texture	Almond	004	Meadow Fern	874		11 pcs/carton (1/2 sq/carton)
						Chesapeake Gray	872	Midnight Surf	652		
Coastal Blue	625	Monterey Sand				673					
Dark Drift	665	Moonlit Moss				653					
Dover Gray	150	Pebble				307					
Harbor Bay	637	Rockport Brown				875					
Hudson Slate	873	Smoked Timber				878					
Iron Ore	642	Snow White				751					
Majestic Brick	876	Storm				631					
Marine Dusk	877	Windswept Smoke				651					
<hr/>											
Traditional Shake Corner 	14972	15.86" Length Natural Cedar Texture				Almond	004	Meadow Fern	874	10 pcs/carton (13.2 lineal ft/carton)	
						Chesapeake Gray	872	Midnight Surf	652		
			Coastal Blue	625	Monterey Sand	673					
			Dark Drift	665	Moonlit Moss	653					
			Dover Gray	150	Pebble	307					
			Harbor Bay	637	Rockport Brown	875					
			Hudson Slate	873	Smoked Timber	878					
			Iron Ore	642	Snow White	751					
			Majestic Brick	876	Storm	631					
			Marine Dusk	877	Windswept Smoke	651					
			<hr/>								
			Hand-Split Shake Corner 	14974	20.18" Length Deep Cedargrain Texture	Almond	004	Meadow Fern	874		10 pcs/carton (16.8 lineal ft/carton)
						Chesapeake Gray	872	Midnight Surf	652		
Coastal Blue	625	Monterey Sand				673					
Dark Drift	665	Moonlit Moss				653					
Dover Gray	150	Pebble				307					
Harbor Bay	637	Rockport Brown				875					
Hudson Slate	873	Smoked Timber				878					
Iron Ore	642	Snow White				751					
Majestic Brick	876	Storm				631					
Marine Dusk	877	Windswept Smoke				651					

PRODUCT	CODE	DESCRIPTION	COLORS				PACKAGING	
Outside Corner Post 	14515	3-1/2" Face 10" length 3/4" receiving channel Brushed finish	Almond	004	Meadow Fern	874	10 pcs/carton	
			Chesapeake Gray	872	Midnight Surf	652		
Coastal Blue	625	Monterey Sand	673					
Dark Drift	665	Moonlit Moss	653					
Dover Gray	150	Pebble	307					
Harbor Bay	637	Rockport Brown	875					
Hudson Slate	873	Smoked Timber	878					
Iron Ore	642	Snow White	751					
Majestic Brick	876	Storm	631					
Marine Dusk	877	Windswept Smoke	651					
Inside Corner Post 	14110	10" length 3/4" receiving channel Brushed finish	Almond	004	Meadow Fern	874		10 pcs/carton
			Chesapeake Gray	872	Midnight Surf	652		
Coastal Blue	625	Monterey Sand	673					
Dark Drift	665	Moonlit Moss	653					
Dover Gray	150	Pebble	307					
Harbor Bay	637	Rockport Brown	875					
Hudson Slate	873	Smoked Timber	878					
Iron Ore	642	Snow White	751					
Majestic Brick	876	Storm	631					
Marine Dusk	877	Windswept Smoke	651					
J-Channel 	14095	3/4" face 12' length 3/4" receiving channel Brushed finish	Almond	004	Meadow Fern	874	40 pcs/carton	
			Chesapeake Gray	872	Midnight Surf	652		
Coastal Blue	625	Monterey Sand	673					
Dark Drift	665	Moonlit Moss	653					
Dover Gray	150	Pebble	307					
Harbor Bay	637	Rockport Brown	875					
Hudson Slate	873	Smoked Timber	878					
Iron Ore	642	Snow White	751					
Majestic Brick	876	Storm	631					
Marine Dusk	877	Windswept Smoke	651					
Wide Face J-Channel 	14093	2-1/2" face 12' length 3/4" receiving channel Brushed finish	Snow White	751				18 pcs/carton

CELLULAR CORNERS AND ACCESSORIES

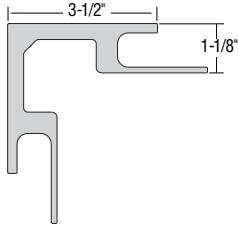
PRODUCT	DESCRIPTION	COLORS
3-1/2" Outside Corner Post with Nailing Flange	3-1/2" face 3/4" receiving channel Smooth finish	White
		

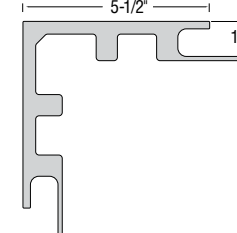
PRODUCT	DESCRIPTION	COLORS
5-1/2" Outside Corner Post with Nailing Flange	5-1/2" face 3/4" receiving channel Smooth finish	White
		

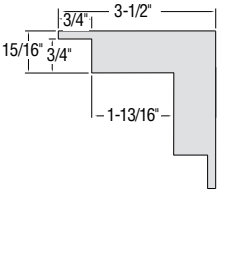
PRODUCT	DESCRIPTION	COLORS
3-1/2" Outside Corner Post with Receiving Channel	3-1/2" face 3/4" receiving channel Smooth finish Nominal size: 5/4 x 4	White
		

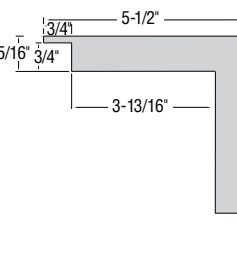
PRODUCT	DESCRIPTION	COLORS
5-1/2" Outside Corner Post with Receiving Channel	5-1/2" face 3/4" receiving channel Smooth finish Nominal size: 5/4 x 6	White
		

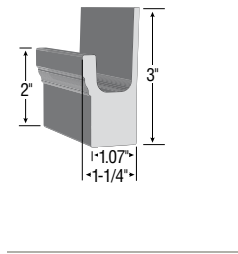
PRODUCT	DESCRIPTION	COLORS
Brickmould with J-Channel and Nailing Flange	3/4" receiving channel Smooth finish Note: Design and dimensions may vary.	White
		

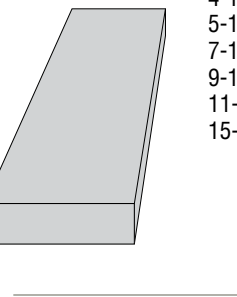
PRODUCT	DESCRIPTION	COLORS
Solid Trim Board	2-1/2" 3-1/2" 4-1/2" 5-1/2" 7-1/4" 9-1/4" 11-1/4" 15-1/4" 20' length Smooth finish Nominal size: 5/4 Note: Use for skirt board, band board and other trim applications. Field routing a receiving channel may be required.	White
		

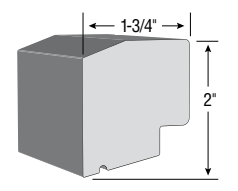
PRODUCT	DESCRIPTION	COLORS
Historic Sill Moulding	Smooth finish Note: Design and dimensions may vary.	White
		

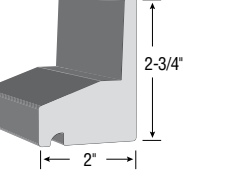
PRODUCT	DESCRIPTION	COLORS
Water Table Moulding	Smooth finish Note: Field removal of flange required. Design and dimensions may vary.	White
		

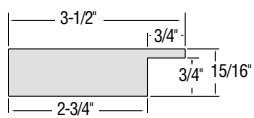
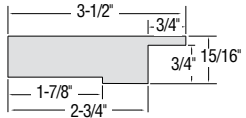
PRODUCT	DESCRIPTION	COLORS
<p>3-1/2" Casing with J-Channel and Nailing Flange</p> 	<p>3-1/2" face 3/4" receiving channel Natural cedargrain texture</p>	<p>White</p>
<p>3-1/2" Casing with Receiving Channel</p> 	<p>3-1/2" face 3/4" receiving channel Natural cedargrain texture Nominal size: 5/4 x 4</p>	<p>White</p>
<p>3-1/2" Casing with Receiving Channel and Nailing Flange Cutout</p> 	<p>3-1/2" face 3/16" x 1-7/8" window nailing flange cutout 3/4" receiving channel Natural cedargrain texture Nominal size: 5/4 x 4</p>	<p>White</p>
<p>5-1/2" Casing with Receiving Channel</p> 	<p>5-1/2" face 3/4" receiving channel Natural cedargrain texture Nominal size: 5/4 x 6</p>	<p>White</p>
<p>5-1/2" Casing with Receiving Channel and Nailing Flange Cutout</p> 	<p>5-1/2" face 3/16" x 1-7/8" window nailing flange cutout 3/4" receiving channel Natural cedargrain texture Nominal size: 5/4 x 6</p>	<p>White</p>

ALUMINUM TRIM COIL

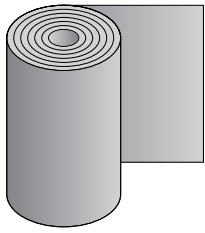
PRODUCT	CODE	DESCRIPTION	COLORS				PACKAGING
Poly Aluminum Trim Coil 	0737107	24" x 50" Color over bright white .019 nominal thickness 27 lbs/roll	Almond	004	Marine Dusk	877	1 roll/carton 32 rolls/skid
			Bright White	068	Meadow Fern	874	
			Chesapeake Gray	872	Midnight Surf	652	
			Coastal Blue	625	Monterey Sand	001	
			Dark Drift	665	Moonlit Moss	653	
			Dover Gray	151	Pebble	307	
			Harbor Bay	637	Rockport Brown	875	
			Hudson Slate	873	Smoked Timber	878	
			Iron Ore	642	Storm	631	
			Majestic Brick	876	Windswept Smoke	651	

PVC Aluminum Trim Coil 	0710007	24" x 50" .019 nominal thickness 28 lbs/roll	Almond	004	Marine Dusk	877	1 roll/carton 32 rolls/skid
			Bright White	068	Meadow Fern	874	
			Chesapeake Gray	872	Midnight Surf	652	
			Coastal Blue	625	Monterey Sand	001	
			Dark Drift	665	Moonlit Moss	653	
			Dover Gray	151	Pebble	307	
			Harbor Bay	637	Rockport Brown	875	
			Hudson Slate	873	Smoked Timber	878	
			Iron Ore	642	Storm	631	
			Majestic Brick	876	Windswept Smoke	651	

SHERWIN-WILLIAMS® COLOR MATCH FORMULAS

Color Name	Color Cast Eco Toner	oz.	32	64	128
SNOW WHITE	W1 White	12	-	-	-
SW Color ID: GBP0019					
ALMOND	L1 Blue	-	4	-	1
	R3 Magenta	-	8	-	1
SW Color ID: GBP0002					
MONTEREY SAND	B1 Black	-	16	1	1
	R3 Magenta	-	8	-	-
	Y3 Deep Gold	-	32	1	1
SW Color ID: GBP0013					
PEBBLE	W1 White	2	39	1	1
	L1 Blue	-	9	-	-
	N1 Raw Umber	8	12	-	1
	R2 Maroon	-	3	-	-
SW Color ID: GBP0015					
DARK DRIFT	B1 Black	2	46	1	1
	R2 Maroon	-	4	1	-
	R3 Magenta	2	-	1	-
	Y3 Deep Gold	6	12	-	1
SW Color ID: GBP0003					
ROCKPORT BROWN	B1 Black	6	2	1	1
	R2 Maroon	-	31	1	1
	R3 Magenta	-	3	1	-
	Y3 Deep Gold	4	26	-	-
SW Color ID: GBP0009					
SMOKED TIMBER	W1 White	-	11	-	-
	B1 Black	-	33	1	-
	L1 Blue	-	45	1	1
	R3 Magenta	2	41	1	1
	Y3 Deep Gold	2	59	1	1
SW Color ID: GBP0016					
DOVER GRAY	B1 Black	-	40	-	-
	R2 Maroon	-	1	-	1
	Y3 Deep Gold	-	9	1	1
SW Color ID: GBP0021					
CHESAPEAKE GRAY	W1 White	4	15	-	1
	B1 Black	2	29	-	-
	N1 Raw Umber	4	19	1	1
SW Color ID: GBP0017					
STORM	W1 White	2	26	-	-
	L1 Blue	-	21	1	1
	N1 Raw Umber	6	60	-	-
	R3 Magenta	-	33	-	-
	G2 New Green	-	6	-	-
	Y3 Deep Gold	-	7	-	-
SW Color ID: GBP0018					
HUDSON SLATE	W1 White	-	56	1	-
	B1 Black	2	39	1	1
	G2 New Green	-	-	1	1
	N1 Raw Umber	6	22	1	-
	R2 Maroon	-	8	1	-
SW Color ID: GBP0001					
WINDSWEPT SMOKE	B1 Black	6	47	-	1
	R2 Maroon	-	20	1	-
	Y3 Deep Gold	2	60	-	1
SW Color ID: GBP0006					
IRON ORE	W1 White	-	8	-	1
	L1 Blue	2	56	1	-
	R2 Maroon	-	24	-	1
	R3 Magenta	2	18	-	-
	Y3 Deep Gold	2	21	-	-
SW Color ID: GBP0005					
COASTAL BLUE	W1 White	2	36	1	1
	L1 Blue	4	34	-	-
	R2 Maroon	-	27	-	-
	R3 Magenta	-	13	1	1
SW Color ID: GBP0011					
ROCKWELL BLUE	W1 White	-	63	-	1
	B1 Black	2	61	-	-
	L1 Blue	-	57	-	1
	N1 Raw Umber	2	43	-	-
	R3 Magenta	-	31	1	1
SW Color ID: GBP0010					
MIDNIGHT SURF	W1 White	-	9	1	-
	B1 Black	8	18	-	1
	Y3 Deep Gold	-	36	-	1
SW Color ID: GBP0012					
MARINE DUSK	L1 Blue	4	29	-	-
	R2 Maroon	-	12	-	-
	R3 Magenta	4	22	-	-
	Y3 Deep Gold	2	1	-	-
SW Color ID: GBP0020					
MEADOW FERN	W1 White	-	29	1	-
	B1 Black	-	45	-	-
	L1 Blue	-	23	1	1
	N1 Raw Umber	8	29	1	-
SW Color ID: GBP0014					
MOONLIT MOSS	B1 Black	6	4	-	1
	Y3 Deep Gold	2	59	1	1
SW Color ID: GBP0007					
MAJESTIC BRICK	L1 Blue	-	56	-	-
	R2 Maroon	2	18	-	1
	R3 Magenta	4	25	-	1
	Y3 Deep Gold	2	28	1	-
SW Color ID: GBP0008					

Please note: Gentek is not responsible for paint color formulation. Matching paint colors may vary slightly from colors of ALIGN product. Consult with Sherwin-Williams personnel prior to use. All paint color matches are determined with Sherwin-Williams SuperPaint® Exterior Acrylic Latex Satin Finish in one gallon quantities. Use Sherwin-Williams color ID for quantities and finishes other than Sherwin-Williams one gallon SuperPaint Exterior Acrylic Latex Satin Finish. **Sherwin-Williams Stores:** The SW color ID can be found under the "Competitive Color" menu. The colors can be found under the company name COIL NA.



3773 State Road, Cuyahoga Falls, Ohio 44223
www.gentekinc.com
Make us a part of your home.

Product improvement policy: Gentek Building Products is constantly improving product designs and manufacturing processes. We therefore must reserve the right to change specifications without notice. Colors may be slightly different from their appearance in this brochure. Make final color selections using actual product samples. Trademarks mentioned in this document are the property of Gentek Building Products, its affiliates, or their respective owners.